

HELIUS

Deye®

User Manual

Spring series LFP Battery

SE-F5 Plus

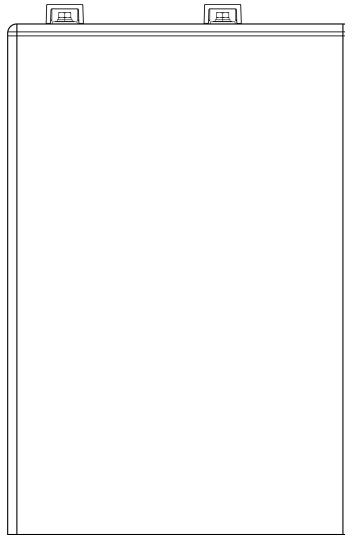

Issue: 07

Date: 20250807

How to Use This Manual

Read the manual and other related documents before performing any operation on the battery. Documents must be stored carefully and be always available.

Contents may be periodically updated or revised due to product development. The information in this manual is subject to change without notice.

All Rights Reserved

No part of this document can be reproduced in any form or by any means without the formal permission of the manufacturer.

Trademarks and Permissions

Trademarks used in this manual are owned by the manufacturer. All other trademarks or registered trademarks mentioned in this manual are owned by their respective owners.

Software Licenses

- * It is prohibited to use data contained in firmware or software developed by the manufacturer , in part or in full, for commercial purposes by any means.
- * It is prohibited to perform reverse engineering, cracking, or any other operations that compromise the original program design of the software developed by the manufacturer.

Disclaimer

The manufacturer shall not be liable for personal injury, property loss, product damage and subsequent losses under the following circumstances:

- * Damages caused by force majeure, including earthquake, flood, volcanic eruption, mudslide,, lightning, fire, war, military conflict, typhoon, hurricane, and so on.
- * Failure to comply with the provisions of this manual.
- * The installation, operation and storage environment does not meet the relevant international, national or regional standards;
- * Incorrect use of this product.
- * Unauthorized or unqualified personnel repair the product, disassembly the rack and perform other operations.
- * Use of unapproved spare parts.
- * Unauthorized modifications or technical changes to the product or software.
- * Incorrect shipment by yourself or the third party commissioned by you.
- * Unsatisfactory materials and tools from you own that do not meet the relevant international, national or regional standards.
- * Damage caused by yourself or the third party's negligence, intent, gross negligence, or improper operation.

Contents

1 Safety Instructions.....	4
1.1 Terms and Symbols.....	4
1.2 Safety Rules.....	6
2 Product Description.....	7
2.1 Product Features.....	7
2.2 Application Scenarios.....	7
2.3 Model Description.....	8
2.3.1 SE-F5 Plus-L.....	8
2.3.2 SE-F5 Plus-E.....	9
2.3.3 SE-F5 Plus-C.....	10
2.4 Product Overview.....	12
3 Preparation for Installation.....	14
3.1 Unpacking List.....	14
3.2 Required Tools.....	16
3.3 Safety Gear.....	16
4 Installation Instructions.....	18
4.1 Installation Personnel.....	18
4.2 Installation Environment.....	19
4.3 Selection of Installation Sites.....	22
4.4 Installing the Battery.....	23
4.4.1 Wall-mounted/Floor-mounted.....	23
4.4.2 Stack-mounted.....	25
5 Electrical Connection.....	27
5.1 System Connection Precautions.....	27
5.2 Preparation before Wiring.....	27
5.3 Parallel Mode 1.....	28
5.4 Parallel Mode 2.....	29
5.5 Grounding.....	30
6 Operating the Product.....	30
6.1 Power on/off the Product.....	30
6.2 Buzzer.....	31
6.3 How to utilize your APP?.....	32
7 Inspection, Cleaning and Maintenance.....	33
7.1 General Information.....	33
7.2 Inspection.....	33
7.3 Cleaning.....	33
8 Storage.....	34
9 Troubleshooting.....	35
10 Technical Specifications.....	37

11 Environmental Disposal 38
12 Transportation Requirements 39

1 Safety Instructions







Warning!

Read and follow carefully all safety warnings and all instructions . Failure to do so may result in electrical shock, fire, serious injury, or death. Save these instructions for future reference.

1.1 Terms and Symbols

Terms /Symbols	Description
Danger	Indicates a hazard with a high level of risk which, if not avoided, will result in death or serious injury.
Warning	Indicates a hazard with a medium level of risk which, if not avoided, will result in death or serious injury.
Caution	Indicates a hazard with a low level of risk which, if not avoided, will result in minor or moderate injury.
Notice	Indicates a potentially hazardous situation which, if not avoided, could results in equipment damage, data loss, performance deterioration, or unanticipated results. NOTICE is used to address practices not related to personal injury.
Note	Supplements the important information in the main text. NOTE is used to address information not related to personal injury, equipment damage, and environment deterioration.
	Caution , risk of electric shock symbol indicates important safety instructions , which if not correctly followed , could result in electric shock.
	The DC input terminals of the inverter must not be grounded.
	Surface high temperature , Please do not touch the inverter case .
	CE mark of conformity
	Please read the instructions carefully before use .
	Indicate that this product is recyclable
	Do not place near open fire or incinerate. Do not use near heaters or hot temperature source.
	Attention! The risk of explosion.

	<p>Li-ion battery</p>
	<p>Do not tread</p>
	<p>Do not run and chase</p>
	<p>Do not touch with your palm</p>
	<p>Symbol for the marking of electrical and electronics devices according to Directive 2002/96/ EC. Indicates that the device , accessories and the packaging must not be disposed as unsorted municipal waste and must be collected separately at the end of the usage . Please follow Local Ordinances or Regulations for disposal or contact an authorized representative of the manufacturer for information concerning the decommissioning of equipment.</p>

1.2 Safety Rules

- 1) After unpacking, please check product and packing list first, if product is damaged or lack of parts, please contact with the local retailer.
- 2) Before installation, be sure to cut off the grid power and make sure the battery is in the turned-off mode.
- 3) Wiring must be correct. Be careful to negative pole and positive of cable and terminals. Make sure no short circuit with the external device.
- 4) It is prohibited to connect the battery and AC power directly.
- 5) Please ensured the electrical parameters of battery system are compatible to related equipment.
- 6) Do not allow the terminals to contact exposed wire or metal.
- 7) Keep out of reach of children or animals.
- 8) Do not place batteries near fire, heater or high temperature sources. This will reduce the risk of explosion or possible injury.
- 9) Batteries can explode in the presence of a source of ignition, such as open flame. An exploded battery can propel debris and chemicals. If occurs, flush with water immediately.
- 10) Do not submerge the battery in water or expose it to moisture. Do not disassemble or alter the battery in any way.
- 11) If the battery system needs to be moved or repaired, the power must be cut off and the battery is completely shut down.
- 12) It is prohibited to connect the battery with different type of Battery.
- 13) It is prohibited to put the batteries into use with faulty or incompatible power conversion system (hereafter refers to "PCS").
- 14) It is prohibited to disassemble the battery.
- 15) In case of fire, only dry fire extinguishers can be used. Liquid fire extinguishers are forbidden.
- 16) Please do not open, repair, or disassemble the battery except qualified personnel. We do not undertake any consequences or related responsibility which be- cause of violation of safety operation or violating of design, production, and equipment safety standards.
- 17) Battery needs to be recharged within 48 hours after fully discharged.
- 18) Do not expose cable outside.
- 19) Do not expose battery to flammable or harsh chemicals or vapors.
- 20) Do not paint any part of Battery, include any internal or external components.
- 21) Do not connect battery with PV solar wiring directly.
- 22) Any foreign object is prohibited to insert into any part of battery.
- 23) Do not strike, drop, puncture or step on the battery. A damaged battery is subjected to explosion. Properly dispose of damaged battery immediately.
- 24) In case of electrolyte leakage, keep leaked electrolyte away from contact with eye or skin, If that occurs, wash immediately with clean water for at least 10 minutes, then seek immediate medical attention.

2 Product Description

2.1 Product Features

- 1) The lithium iron phosphate battery is one of new energy storage products, which can be used to support reliable power for various types of equipment and systems. The whole module is non-toxic, non-polluting, and environmentally friendly.
- 2) This product has built-in BMS battery management system, which can manage and monitor cells information including voltage, current and temperature. What' s more, BMS can balance cells charging and discharging to extend cycle life.
- 3) Cathode material is made from LiFePO_4 with safety performance and long cycle life.
- 4) Flexible configuration. Multiple batteries can be in parallel for expanding capacity and power.
- 5) Adopted self-cooling mode rapidly reduces system noise.
- 6) The module has less self-discharge, no memory effect, excellent performance of shallow charge and discharge.
- 7) Battery module communication address auto networking, easy maintenance, support remotely monitoring and upgrade the firmware.
- 8) High-power density: flat design, stack-mounted, saving installation space.

2.2 Application Scenarios

The following illustration shows basic application of this battery.

It also includes following devices to have a complete running system.

- Generator or Utility
- PV modules
- Low voltage Hybrid PCS (Charge & Discharge)

Consult with your system integrator for other possible system architectures depending on your requirements.

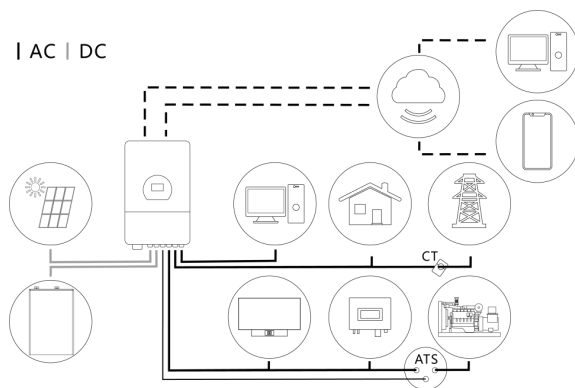

2.3 Model Description

Your product is mainly divided into three categories due to different configurations, **SE-F5 Plus-L**, **SE-F5 Plus-E** and **SE-F5 Plus-C**. This section will focus on the differences among these three versions.

Model	Version	Configuration
SE-F5 Plus	SE-F5 Plus-L	Deye Logo
	SE-F5 Plus-E	LED indicator
	SE-F5 Plus-C	LCD screen

2.3.1 SE-F5 Plus-L

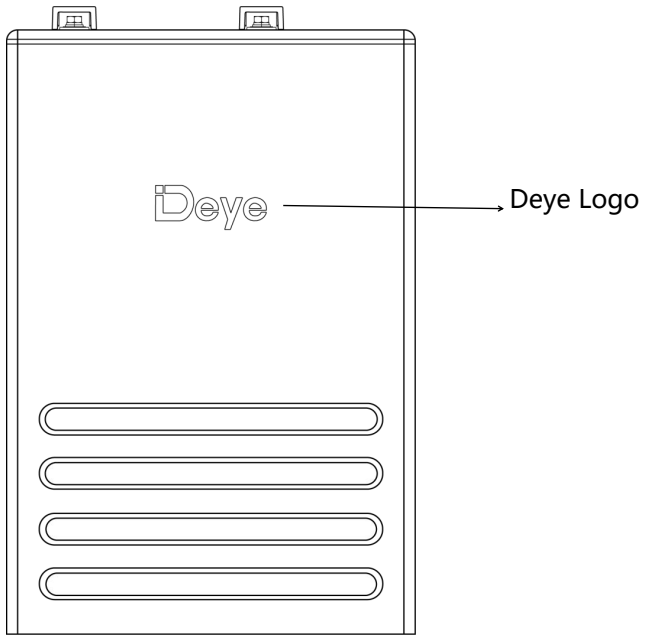

2.3.2 SE-F5 Plus-E

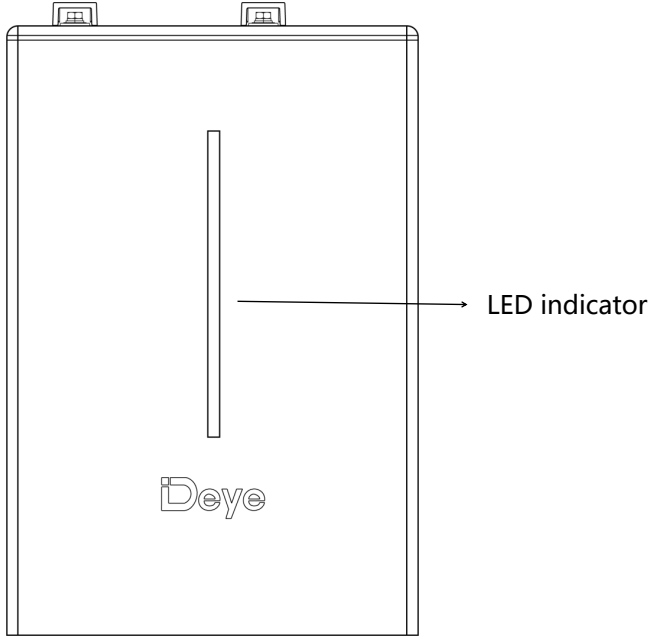

LED indicator Instructions

Error : Red on the right and green on the left, long bright if equipment protected.

SOC : Battery capacity indicator, green light strip.

Condition	Error	SOC	SOC	SOC	SOC	SOC
		0%~20%	0%~40%	0%~60%	0%~80%	0%~100%
SOC						
Power off		off				
Charge	off	 Show SOC & highest LED blink				
Discharge or Idle	off	 Show SOC & long bright				
Alarm	off	 Other LEDs are same as above.				
System error/Protect						
Upgrade		Blink Fastly				
Critical Error		Blink Slowly				

2.3.3 SE-F5 Plus-C

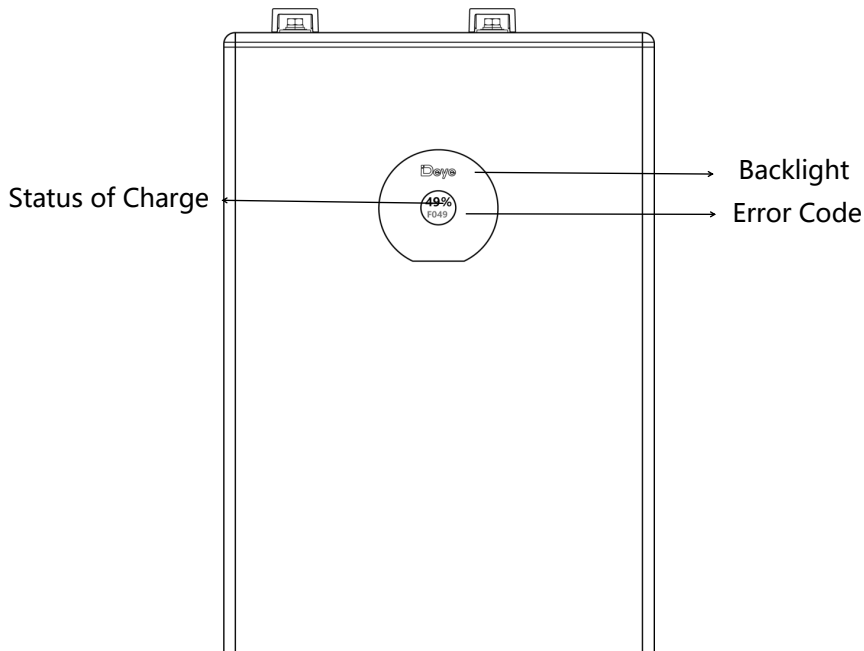

Condition	Performance
Normal	After initialized successfully, the LCD screen will be on for long time and shows the SOC in percentage. The screen stays on unless shutdown and dormancy. The backlight in the shape of Deye appears blue.
Abnormal	If the fault in the next table occurs, the corresponding fault code will be displayed on the LCD screen. For details, refer to the next table. The backlight in the shape of Deye appears red.
Upgrade	When upgrading, the screen will be filled with the "upd" as well as the upgrade process in percentage. The backlight in the shape of Deye appears blue.
Others	1. The Deye backlight displays red and flash quickly when there is a communication failure between the LCD screen and the BMS motherboard. 2. The Deye backlight displays red while the system is upgrading with faults existing.

Error Code	Connotation	Error Code	Connotation
01	Cell over voltage	28	Mosfet short circuit
02	Cell under voltage	29	EEPROM error
04	Ultimate_Protection	30	Internal communication fails
05	Charge over current	31	PCS communication fails
06	Discharge over current	32	Master address repeat
07	Cell over temperature	45	Cur Limit Mos Adhesion
08	Cell under temperature	46	Mos Adhesion Susp
11	Cell voltage over difference	47	Heat Mos adhesion
12	Cell temperature over difference	48	Heat error
13	Mos over temperature	49	Over connect temp
14	Heating film over temperature	50	Pre charge fail
19	AFE-OCDL/OCD1/OCD2	51	Charge inverses
24	AFE-SCDL/SCD	52	Over terminal temp
25	AFE communication fails	53	Fuse blown
26	Cell voltage sampling fails	54	VOLT_OPEN_WIRE_FAIL
27	Temperature sampling fails	55	TEMP_OPEN_WIRE_FAIL

2.4 Product Overview

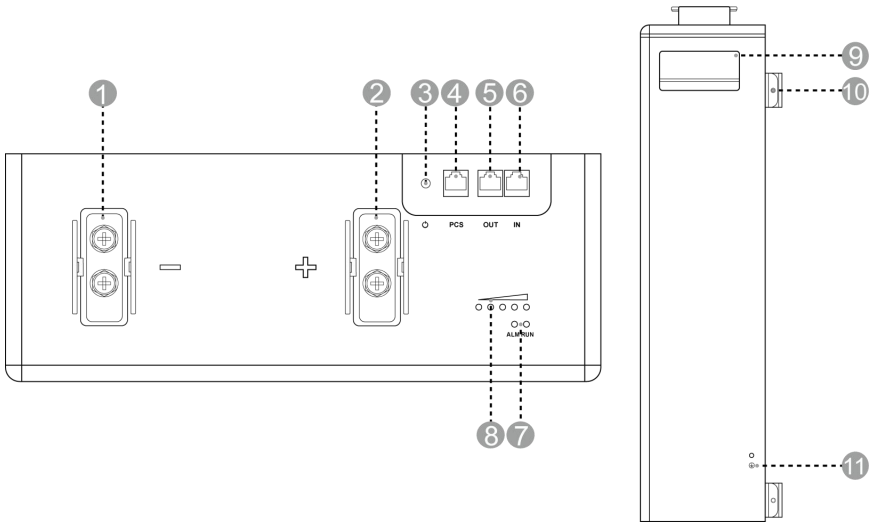

1. P- port	7. Status indicators
2. P+ port	8. SOC indicators
3. Battery switch	9. Handle
4. PCS port	10. Bracket mount
5. OUT port	11. Protective earth
6. IN port	

P+ port

Positive output terminal.

P- port

Negative output terminal.

PCS port

Inverter communication terminal, to follow the CAN protocol (baud rate:500kbps),and RS485(baud rate:9600bps), used to output battery information to the inverter.

OUT port

Communication output terminal(RJ45port), to connect the "IN" terminal of next battery for communication between multiple parallel batteries.

IN port

Communication input terminal(RJ45port), to connect the "OUT" terminal of previous battery for communication between multiple parallel batteries.

Battery switch

To power on /off the battery.

SOC indicators:

To display the state of remaining charge by 5 LED lights. Every LED indicates the SOC of 20%, 40%, 60%,80% and 100%.

Status indicators

RUN light: green LED lighting to show the battery running status.







Alarm light: yellow LED lighting to show the battery has been alarmed.

Condition	RUN	ALM	SOC1	SOC2	SOC3	SOC4	SOC5
Power Off	Off						
Discharge or Idle	Blink	Blink if Alarm Exists	e.g., SOC67%				
			Off	On	On	On	On
Charge		Blink	e.g., SOC47%:				
			Off	Off	Blink	On	On
Alarm		Blink	Blink	Same as 'Discharge or Idle'			
System Error/Protection							
Upgrade	Blink quickly						
Critical Error	Blink slowly						

3 Preparation for Installation

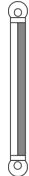
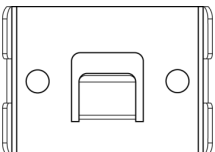
After unpacking, check that packing contents are intact and complete, and free from any damage. If any item listed in the Unpacking List is missing or damaged, contact your vendor.

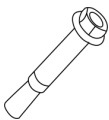
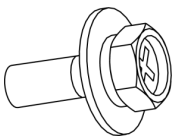
3.1 Unpacking List

		
<p>Battery pack*1pcs</p>	<p>26AWG 1000mm PCS communication cable *1pcs</p>	<p>10AWG 1000mm Ground wire*1pcs</p>
		
<p>Hook*2pcs</p>	<p>4AWG 1000mm Positive battery power cable*1pcs</p>	<p>4AWG 1000mm Negative battery power cable*1pcs</p>
		
<p>Expansion bolt*4pcs (M6*100)</p>	<p>Bolt*4pcs (M4*12)</p>	<p>User manual*1pcs</p>

		
<p>Bracket *4pcs</p>	<p>Logo sticker*1 pcs</p>	<p>Positioning paperboard*1 pcs</p>

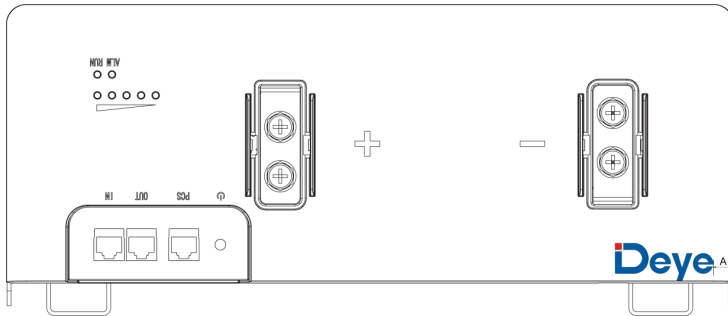

NOTE: Users may refer to the images below for guidance on applying the logo stickers.





Item	Distance (mm)
A	10

3.2 Required Tools

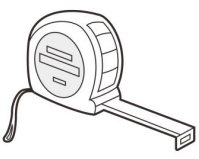
These tools are required to install the battery.

		
<p>Hammer</p>	<p>Drill</p>	<p>Tape measure</p>

		
<p>Hexagon socket wrench</p>	<p>Phillips screwdriver</p>	<p>Marker</p>



Note:

Use properly insulated tools to prevent accident tale electric shock or short circuits. If insulated tools are not available, cover the entire exposed metal surfaces of the available tools, except their tips, with electrical tape.

3.3 Safety Gear

It is recommended to wear the following safety gear when dealing with the battery pack.

		
Insulated gloves	Safety shoes	Safety goggles

4 Installation Instructions

4.1 Installation Personnel

- Only qualified professionals or trained personnel are allowed to install the equipment.
- Professionals:personnel who are familiar with the working principles and structure of the equipment, trained or experienced in equipment operations and are clear of the sources and degree of various potential hazards in equipment installation.
- Trained personnel:personnel who are trained in technology and safety have required experience,are aware of possible hazards on themselves in certain operations and are able to take protective measures to minimize the hazards on themselves and other people.
- Personnel who plan to install the equipment must receive all necessary safety precautions and local relevant standards.
- Only qualified professionals are allowed to remove safety facilities and inspect the equipment.
- Knowledge of electronic, electrical wiring and mechanical expertise, and be familiar with electrical and mechanical schematics.
- Understanding and complying with this document and other applicable documents.

4.2 Installation Environment

 **Danger!**

Do not expose the equipment to flammable or explosive gas or smoke. Do not perform any operation on the equipment in such environments.

 **Danger!**

Do not store any flammable or explosive materials in equipment area. Do not cover or wrap the battery.

 **Danger!**

Do not place the equipment near heat sources or fire sources, such as smoke, candles, heaters, or other heating devices. Overheat may damage the equipment or cause a fire.

 **Warning!**

Install the equipment in an area far away liquids. Do not install it under areas prone to condensation, such as under water pipe and air exhaust vent, or area prone to water leakage, such as air conditioner vents, ventilation vents, or feeder windows of the equipment room. Ensure that no liquid enters the equipment to prevent faults or short circuits.

 **Warning!**

To prevent damage or fire due to high temperature, ensure that the ventilation vents or heat dissipation systems are not obstructed or covered by other objects while the equipment is running.

- The installation and usage environment must meet relevant international, the local laws and regulations. The user is obliged to protect the equipment against fire or other hazards.
- Keep the equipment out of the reach of children and away from daily working or living area, including but not limited to the following areas: studio, bedroom, lounge, living room, music room, kitchen, game room, room theater, sunroom, toilet, bathroom, laundry, and attic.
- Do not install the equipment in places that are enclosed, poorly-ventilated without proper fire fighting facilities, or difficult for firefighters to access.
- Do not install the equipment in an easily accessible position because the temperature of the enclosure and heat sink is high when the equipment is running.
- Do not install the equipment on a moving object, such as ship, train, or car.
- Ensure that the equipment is installed in a clean, dry and well ventilated area with proper temperature, humidity and altitude range. Check for more data in the "Technical Specifications" section.
- Do not install the equipment in an environment with magnetic dust, volatile or corrosive gases, infrared and other radiations, organic solvents, conductive metal, or salty air.
- Do not install the equipment in an area conducive to growth of microorganism such as fungus or mildew.
- Do not install the equipment in an area with strong vibration, noise, or electromagnetic interference.
- Do not install the equipment in a position that may be submerged in water.
- Keep away from the air outlet of PCS to prevent personal injury.
- The floor and walls are completely water proof.
- The wall and floor is flat and level.
- Before installing and powering up the system, dust and iron filings must be removed to keep the environment clean. The system cannot be installed in desert areas without a shell to protect against sand.
- The equipment is designed for indoor use. Please avoid direct sunlight, rain exposure, snow laying up during installation and operation.

 **Caution!**

Moving heavy objects.

Be careful to prevent injury when moving heavy objects. Select an suitable way to moving heavy objects according to product weight.

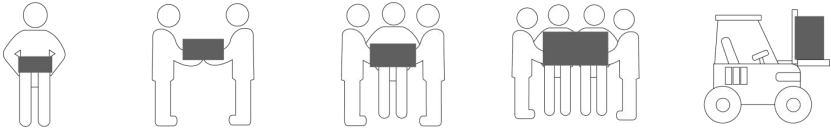

Weight	Method	Recommendation
<18 kg (40lbs)	Manual handling	1 person
18~32 kg (40~70lbs)	Manual handling	2 persons
32~55 kg (40~70lbs)	Manual handling	3 persons
55~68 kg (121~150lbs)	Manual handling	4 persons
> 68 kg (150lbs)	Moving device	Forklift

4.3 Selection of Installation Sites

⚠ Caution!

Batteries should be installed in a clean flat place with no direct sunlight, away from water and fire sources, and at a suitable temperature. The installation location is recommended to meet the size requirements of the figure below: **($0 \leq N \leq 29$)**

NOTE: This requirement only applies to floor-mounted installation.

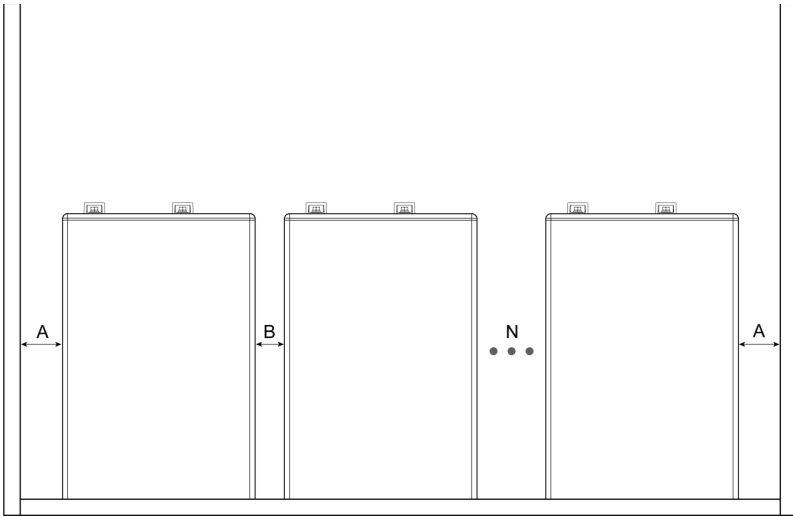

Item	Distance (mm)
A	200
B	100

4.4 Installing the Battery

4.4.1 Wall-mounted/Floor-mounted

1) Choose and mark appropriate locations on the wall for drilling holes with a positioning cardboard.

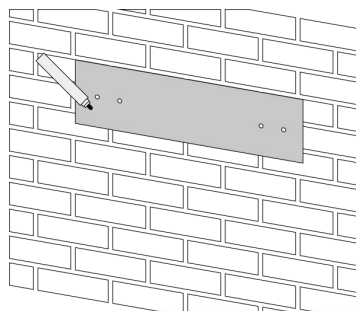
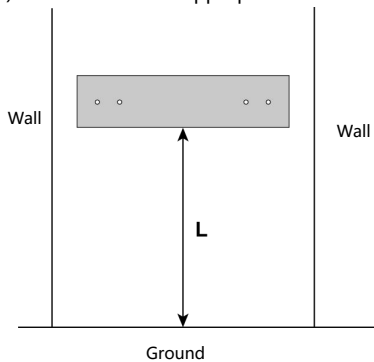

How to differ the floor-mounted installation from the wall-mounted installation depends on the **clearance L** between the ground and the positioning cardboard.

Installation mode	Clearance (mm)
Wall-mounted	$L \geq 530$
Floor-mounted	$L = 430 \pm 2$

2) Drill 4 holes on the wall, with a diameter of 8 mm and depth of 100~110mm.

 Note!

* When drilling holes, pay attention to prevent dust from entering the battery, which may affect the battery performance and function.

* After drilling, never forget to clean up the floor.

3) Fix 2 hooks onto the wall with 4 expansion bolts (M6*100).

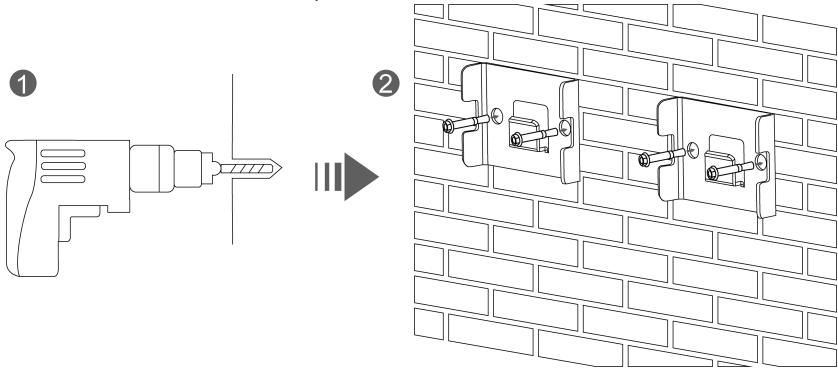

4) Carry the battery and hang it onto the hooks, making sure all bracket mounts on the back of the battery are securely fastened to the hooks on the wall. Secure with two bolts (M4*12).

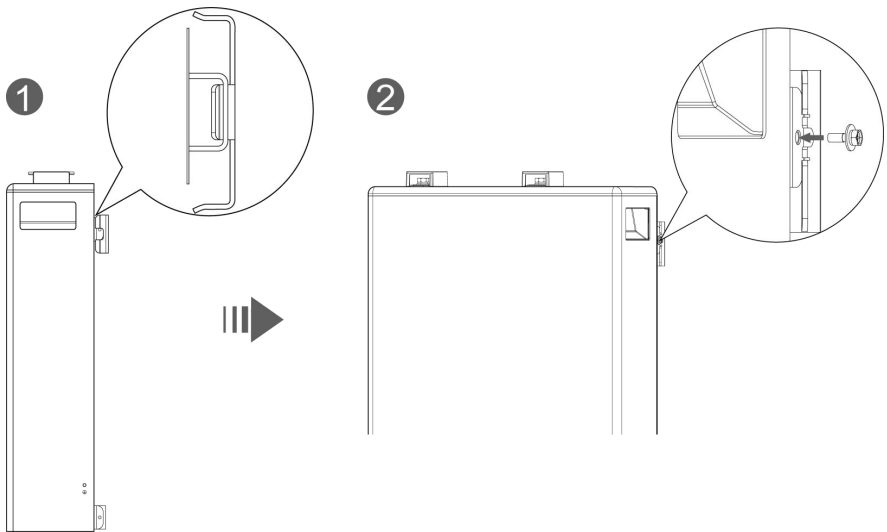

4.4.2 Stack-mounted

1) Remove 8 bolts (M3*10) on every battery that preset at the factory for future use .

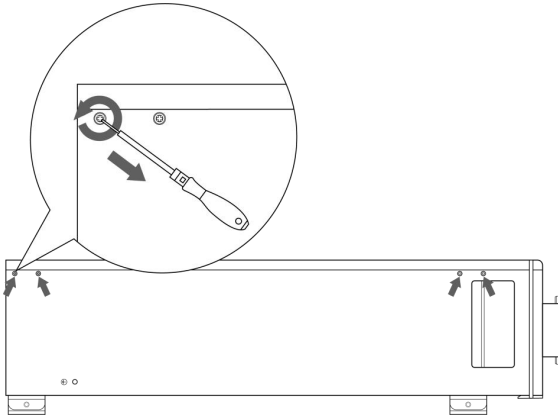

2) Secure 4 brackets to two sides of every battery with 8 bolts (M3*10) mentioned in the step 1.

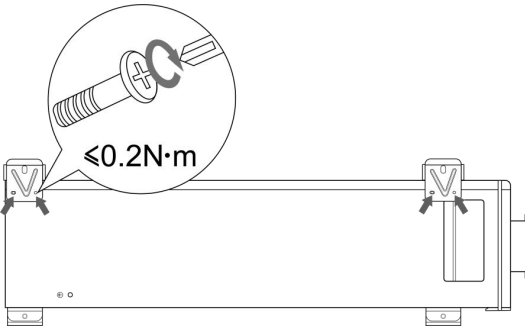

3) Stack the battery one by one and then secure them with 4 bolts (M4*12). The number of stacked batteries can not exceed 6.

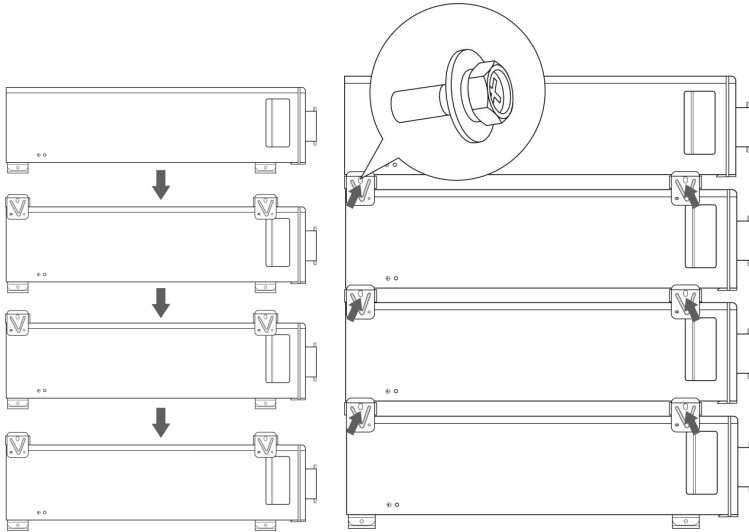

5 Electrical Connection

5.1 System Connection Precautions



Note!

This battery must be used in conjunction with compatible hybrid inverter models. It needs to establish communication with the inverter to activate the lithium battery mode, ensuring optimal battery performance. If used with an unmatched inverter, ensure that the maximum operating current does not exceed 100A for charging and 120A for discharging at an ambient temperature of $25 \pm 2^\circ\text{C}$.

When connecting to inverters or being in parallel mode, please use cables provided in the unpacking list. If other cables must be used in special cases, ensure they meet FCC standards.

5.2 Preparation before Wiring



Note!

- It is noted to distinguish the positive and negative ends of cables.
- Be careful to avoid misuse of lines used for communication between PCS and battery, battery and battery.
- Try to avoid cross-connection.

Before wiring, you need to remove the protective hood to carry out the wire connection.

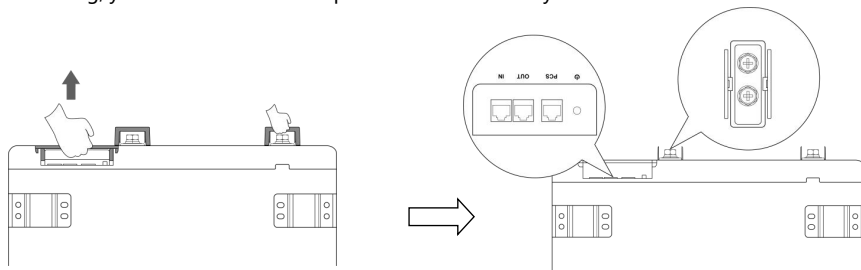

Definition of IN port pin		Definition of OUT port pin		Definition of PCS port pin	
No.	IN port pin	No.	OUT port pin	No.	PCS port pin
1	CANL	1	CANL	1	485-B
2	CANH	2	CANH	2	485-A
3	DI+	3	DO+	3	--
4	DI-	4	DO-	4	CANH
5	DI-	5	DO-	5	CANL
6	DI+	6	DO+	6	--
7	CANH	7	CANH	7	485-A
8	CANL	8	CANL	8	485-B

5.3 Parallel Mode 1

When batteries need to be used together in parallel, you can select different parallel modes to meet your demands.

 **Caution!**

It should be noted that the maximum current of single battery system is **120A**. Exceeding 120A will cause heating of the connectors and cable, and in severe cases, it will cause a fire accident. As for cables, the recommended cross section of them should be at least **4AWG** or **25mm²**.

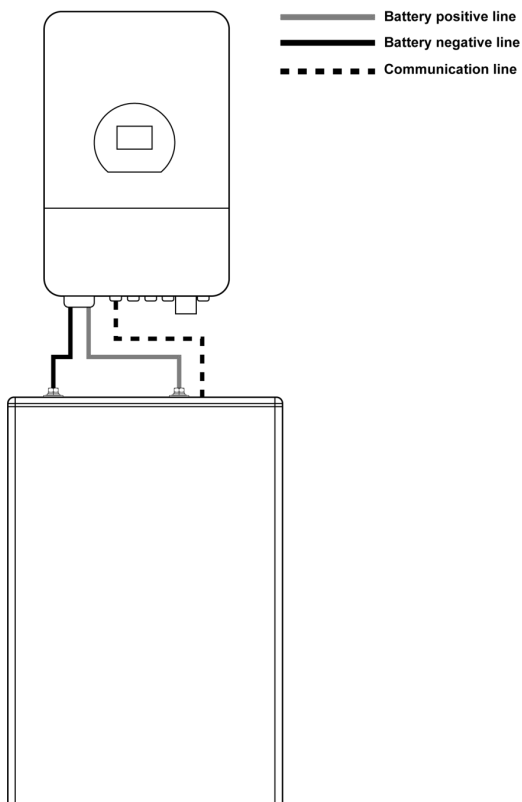

5.4 Parallel Mode 2

Schematic diagram of connection of multiple batteries system:

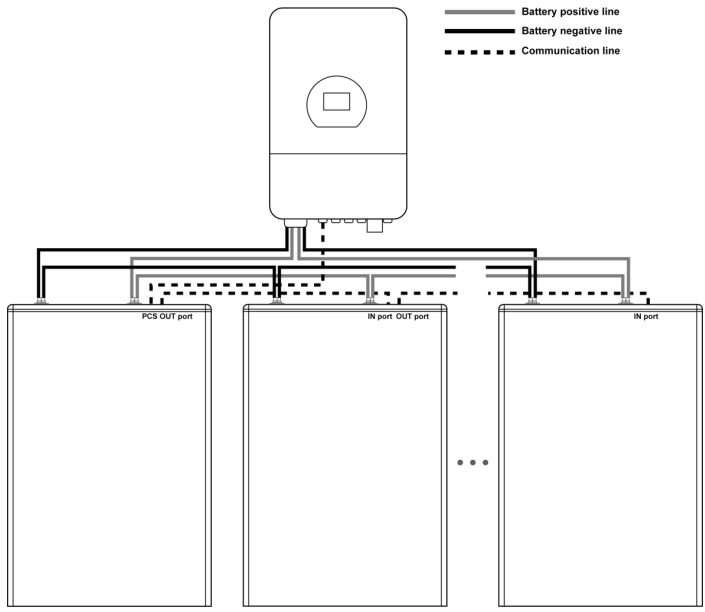

Or

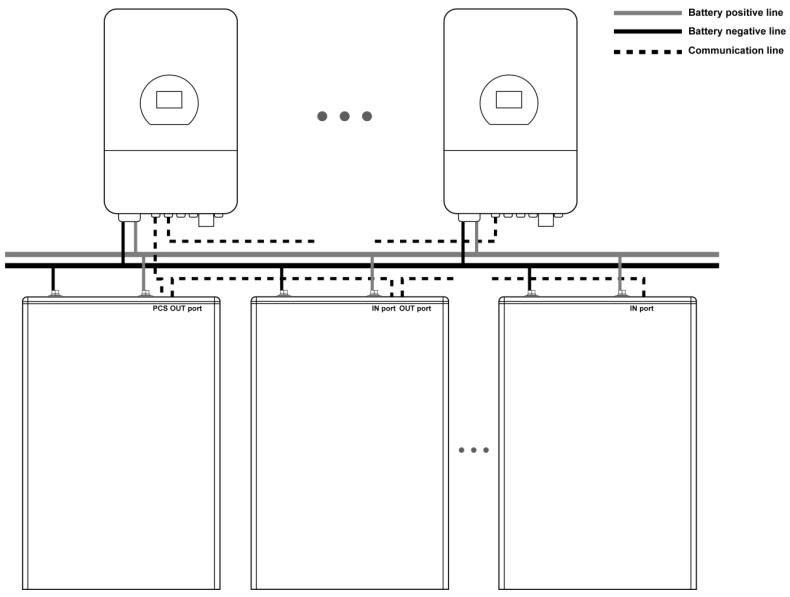

5.5 Grounding

Your battery system must be well grounded. Proceed as follows:

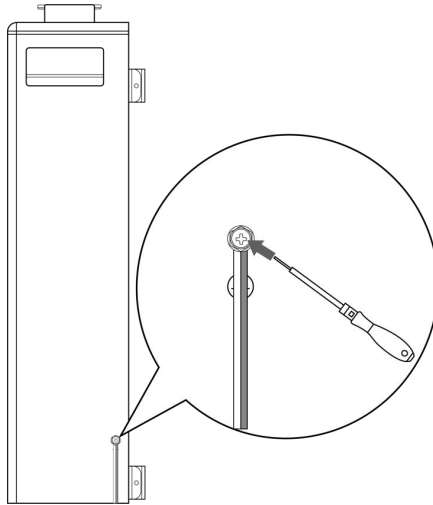

6 Operating the Product

6.1 Power on/off the Product

Before operating the product, ensure that:

- All cables are wired correctly and firmly.
- All fasteners including bolts and screws are tightened firmly.
- No bystanders or animals enter into the working area.
- Keep foreign objects , especially metal, away from the battery .

1. Press the battery switch to to turn on the equipment.
2. After you finish your work, press the battery switch to stop the equipment.

6.2 Buzzer

Your equipment is equipped with a buzzer, which will sound a alarm to reminder that you have to check whether your equipment is in the following situations:

Condition	Possible triggers	Solutions
Alert for 100ms at intervals of 2s with ALARM LED flashing	SOC ≤ 5%, not being charged	Charge the battery in time
Alert once per second with the ALARM LED flashing simultaneously	Inverse connection when charging	Check and and then rectify the wire connection
	There is MOS adhesion existing	Contact the service center
	Cell voltage is higher than 3.8V	Check that sampling line is normal; Test the cell voltage using a multimeter; Inspect the SOH of the battery; Refer to data record for recharge at the low current.
	Discharge/charge temperature is higher than the valve value.	Check that there is rapid charge at the high current or there is a surge on load ; Check that there is long-time charge or over-discharge ; Check that the temperature of the environment around the battery ; Check that the battery is aged or damaged

6.3 How to utilize your APP?

As your device is designed to possess Bluetooth function, it can connect to the Deye Cloud App via Bluetooth. Following successful login and registration, users can retrieve information about battery packs or the entire system. For detailed instructions on the Deye Cloud App, refer to the operation manual by scanning the provided QR code.



7 Inspection, Cleaning and Maintenance

7.1 General Information

- The battery product is not fully charged. It is recommended that the installation be completed within 3 months after arrival;
- During the maintenance process, do not re-install the battery in the battery product. Otherwise, the performance of the battery will be reduced;
- It is forbidden to dismantle any battery in the battery product, and it is forbidden to dis- sect the battery;
- After the battery product is over-discharged, it is recommended to charge the battery within 48 hours. The battery product can also be charged in parallel. After the battery product is connected in parallel, the charger only needs to connect the output port of any product battery.
- Never attempt to open or dismantle the battery! The inside of the battery does not contain serviceable parts.
- Disconnect the Li-Ion battery from all loads and charging devices before performing cleaning and maintenance activities.
- Place the enclosed protective caps over the terminals before cleaning and maintenance activities to avoid the risk of contacting the terminals.
- All the battery terminals must be disconnected for maintenance.
- Please contact the supplier within 24 hours if there is something abnormal.
- Do not use cleaning solvents to clean battery.

7.2 Inspection

- Inspect for loose and/or damaged wiring and contacts, cracks, deformations, leakage, or damage of any other kind. If damage to the battery is found, it must be replaced. Do not attempt to charge or use a damaged battery. Do not touch the liquid from a ruptured battery.
- Regularly check the battery' s state of charge. Lithium Iron Phosphate batteries will slowly self-discharge when not in use or whilst in storage.
- Consider replacing the battery with a new one if you note either of the following conditions:
 - The battery run time drops below 70% of the original run time.
 - The battery charge time increases significantly.

7.3 Cleaning

If necessary, clean the Li-Ion battery with a soft, dry cloth. Never use liquids, solvents, or abrasives to clean the Li-Ion battery.

7.4 Maintenance

The Li-Ion battery is maintenance-free. Charge the battery to approximately > 80% of its capacity at least once every year to preserve the battery capacity.

8 Storage

- The battery product should be stored in a dry, cool, and cool environment;
- If the battery is stored for long time, it is required to charge them every six months, and the SOC should be no less than 50%.
- Generally, the maximum storage period at room temperature is 6 months. When the battery is stored over 6 months, it is recommended to check the battery voltage. If the volt age is higher than 51.2V, it can continue to store the battery. In addition, it is needed to check the voltage at least once a month until the voltage is lower than 51.2V. When the voltage of the battery is lower than 51.2V, it must to be charged according to the charging strategy.
- When the battery product is stored, the source of ignition or high temperature should be avoided and it should be kept away from explosive and flammable areas.
- If your batteries need to be charged or discharged in lead-acid mode, maintain a charge/discharge current of 0.2C within a temperature range of 5°C to 45°C.

9 Troubleshooting

To determine the status of the battery system, users must use additional battery status monitoring software to examine the protection mode. Refer to the installation manual about using the monitoring software. Once the user knows the protection mode, refer to the following sections for solutions.

Fault Type	Phenomenons	Possible Causes	Solutions
Information collection fails	The cell voltage sampling circuit is faulty. The cell temperature sampling circuit is faulty	The welding point for cell voltage sampling is loose or disconnected. The voltage sampling terminal is disconnected. The cell temperature sensor has failed.	Replace the collection line.
Electrochemical cell error	The voltage of the cell is low or unbalanced.	Due to large self- discharge, the cell over discharges to below 2.0V after long term storage. The cell is damaged by external factors, and short circuits, pinpricks, or crushing occur.	Replace the battery.
Over-voltage protection fails	The cell voltage is greater than 3.65 V in charging state. The battery voltage is greater than 58.4 V.	The busbar input voltage exceeds the normal value. Cells are not consistent. The capacity of some cells deteriorates too fast or the internal resistance of some cells is too high.	If the battery cannot be recovered due to protection against abnormality contact local engineers to rectify the fault.
Under voltage protection fails	The battery voltage is less than 44.8V. The minimum cell voltage is less than 2.8V	The mains power failure has lasted for a long time. Cells are not consistent. The capacity of some cells deteriorates too fast or the internal resistance of some cells is too high.	Same as above.
Charge or discharge high temperature	The maximum cell temperature is greater than 60°C	The battery ambient temperature is too high. There are abnormal heat	Same as above.

protection fails		sources around	
Charge low temperature protection fails	The minimum cell temperature is less than 0°C	The battery ambient temperature is too low.	Same as above.
Discharge low temperature protection fails	The minimum cell temperature is less than -20°C	The battery ambient temperature is too low.	Same as above.

10 Technical Specifications

Main Parameter		SE-F5 Plus
Battery Chemistry		LiFePO ₄
Capacity (Ah)		100
Scalability ^[1]		Max.32 pcs in parallel
Nominal Voltage (V)		51.2
Operating Voltage(V)		44.8~57.6
Nominal Energy (kWh)		5.12
Charge Current (A) ^[2]	Max. Continuous	100
	Peak	120 (10 sec)
Discharge Current (A) ^[2]	Max. Continuous	120
	Peak	150 (10 sec)
Other Parameter		
Recommend Depth of Discharge		90% DoD
Dimension (W/H/D, mm)		370×548×140 (Without hanging board)
Weight Approximate		41kg
Master LED indicator		LED(SOC, working, protecting) & Buzzer
IP Rating of enclosure		IP21
Working Temperature		Charge: -10°C ~ 55°C Discharge:-20°C ~ 55°C
Storage Temperature		0°C ~ 35°C
Relative Humidity		95% (no condensing)
Altitude		≤3000m
Cycle Life		≥6000(25°C±2°C,70%EOL)
Installation		Wall-Mounted, Floor-Mounted,Stack-Mounted
Communication Port		CAN2.0, RS485, Bluetooth, APP
Energy Throughput ^[3]		16MWH
Certification		UN38.3, MSDS, CE, CB

[1] Max.64 pcs can parallel with CAN-Box.

[2] The current is affected by temperature and SOC. This max.continuous current is only supported in lithium mode; for lead-acid mode, please refer to the manual for the max.continuous current.

[3] Conditions apply, refer to Deye Warranty Letter.

11 Environmental Disposal

Used batteries can not be disposed of as household waste. You are obliged to handle waste batteries, such as removal of privacy on product, and return them to designated or authorized recovery point according to applicable regulations and standards on waste battery disposal.



Attention:

1. Do not dispose of batteries and rechargeable batteries as domestic waste!
You are legally obliged to return used batteries and rechargeable batteries.
2. Waste batteries may contain pollutants that can damage the environment or your health if improperly stored or handled.
3. Batteries also contain iron, lithium and other important raw materials, which can be recycled.

For more information, please visit <http://www.deyeess.com>. Do not dispose of batteries as household waste!



Li-ion



12 Transportation Requirements

1. The battery products should be transported after packaging and during the transportation process. Severe vibration, impact, or extrusion should be prevented to prevent sun and rain. It can be transported using vehicles such as cars, trains, and ships.
2. Always check all applicable local, national, and international regulations before transporting a Lithium Iron Phosphate battery.
3. Transporting an end-of-life, damaged, or recalled battery may, in certain cases, be specially limited or prohibited.
4. The transport of the Li-Ion battery falls under hazard class UN3480, class 9. For transport over water, air and land, the battery falls within packaging group PI965 Section I. Use Class 9 Miscellaneous Dangerous Goods and UN Identification labels for transportation of lithium-ion batteries which are assigned Class 9. Refer to relevant transportation documents.



Class 9 Miscellaneous Dangerous Goods and UN Identification Label



EU Declaration of Conformity

Product: Rechargeable Li-ion Battery System
System models: SE-F5 Plus

Name and address of the manufacturer: NINGBO DEYE ESS TECHNOLOGY CO., LTD.
No.568, South Rixian Road, Binhai Economic Development Zone, Cixi, Ningbo, Zhejiang, P.R.China

This declaration of conformity is issued under the sole responsibility of the manufacturer. Also this product is under manufacturer's warranty.

This declaration of conformity is not valid any longer: if the product is modified, supplemented or changed in any other way, as well as in case the product is used or installed improperly.

The object of the declaration described above is in conformity with the relevant Union harmonization legislation: The Electromagnetic Compatibility (EMC) Directive 2014/30/EU and the Radio Equipment Directive (RED)2014/53/EU.

References to the relevant harmonized standards used or references to the other technical specifications in relation to which conformity is declared:

EN IEC 61000-6-1: 2019 EN IEC 61000-6-3: 2021	●
ETSI EN 300 328 V2.2.2(2019-07)	●
ETSI EN 301 489-1 V2.2.3(2019-11)	●
ETSI EN 301 489-17 V3.2.4(2020-09)	●
EN IEC 62311:2020	●

Nom et Titre / Name and Title:

KunLei Yu
Test Manager

Au nom de / On behalf of:

NINGBO DEYE ESS TECHNOLOGY CO., LTD.
2025-7-11 宁波德业储能科技有限公司
Ningbo, China
NINGBO DEYE ESS TECHNOLOGY CO.,LTD

Date / Date (yyyy-mm-dd):

A / Place :

EU DoC-v1

NINGBO DEYE ESS TECHNOLOGY CO., LTD

No.568, South Rixian Road, Binhai Economic Development Zone, Cixi, Ningbo, Zhejiang, P.R.China